

Sabdrain

drainage channel system



Scheda tecnica

technical features / fiche technique / ficha técnica

CODE
10 704C

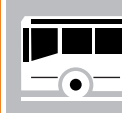

C250



EN
1433

n.1 Canale PP con
bordi in plastica

n.2 Griglie in ghisa
sferoidale

n.1 Kit di fissaggio
n.8 viti M10x30
n.8 piastrini

n.1 Plastic edged
PP channel

n.2 Ductile iron
grids

n.1 Fixing kit
n.8 screws M10x30
n.8 plates

n.1 Caniveau en PP

n.2 Grilles en
fonte ductile

n.1 Kit de fixation
n.8 vis M10x30
n.8 plaques

n.1 Canal de PP

n.2 Rejillas de
hierro dúctil

n.1 Kit de fijación
n.8 tornillos M10x30
n.8 pletina



C250



EN 1433

Code: 510 1510 704CS 150X100

Sabdrain

Canale PP con bordi in plastica

Plastic edged PP channel

Caniveau en PP

Canal de PP

Code: 510 1510

kg/m: 2,9

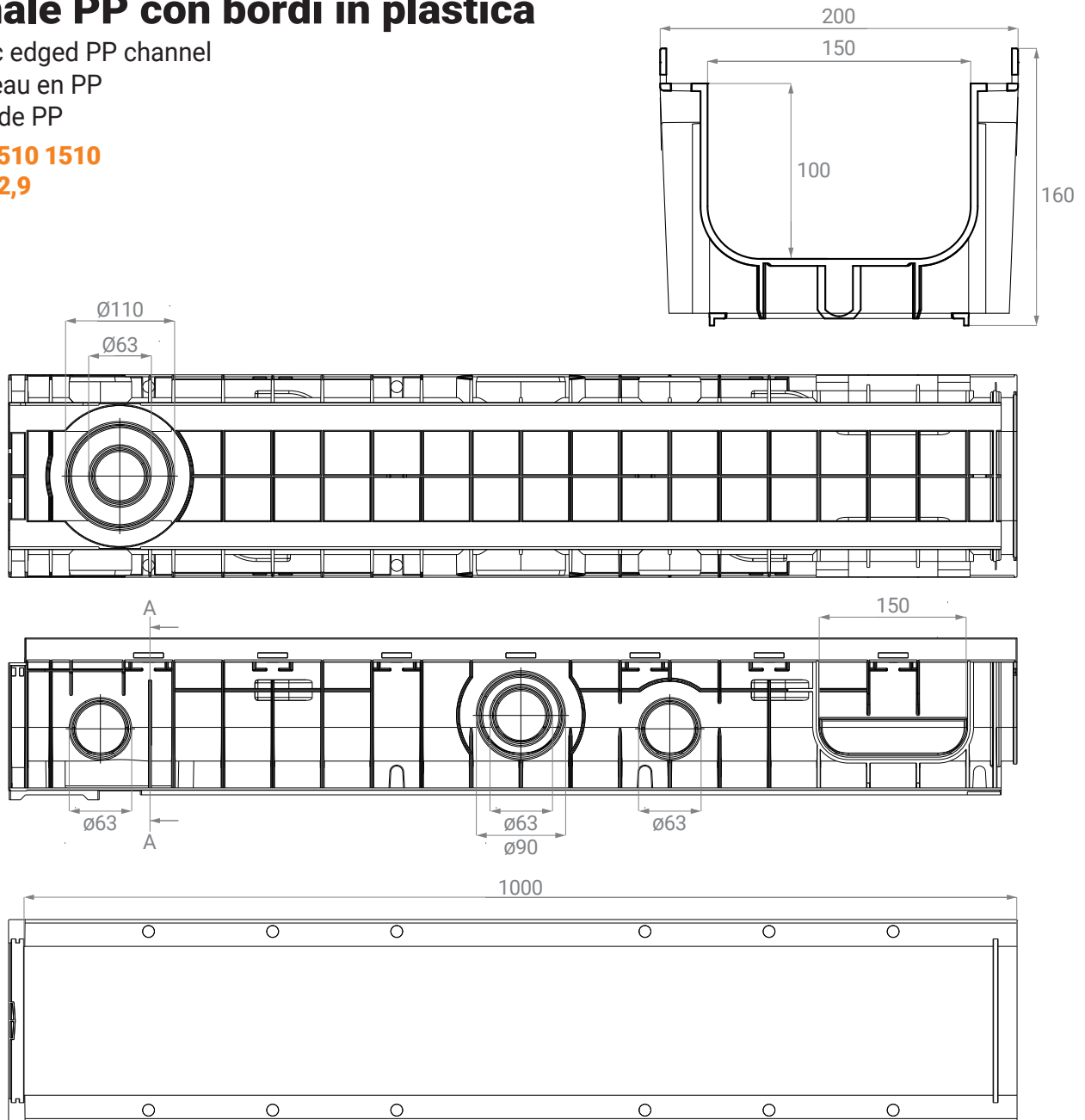

Griglie in ghisa sferoidale

Ductile iron grids

Grilles en fonte ductile

Rejillas de hierro dúctil

Code: 704C15

Drain cm²/m: 696

kg/m: 11,5

